

TL1451A-Q1 DUAL PULSE-WIDTH-MODULATION CONTROL CIRCUITS

SGLS304A – JUNE 2005 – REVISED JUNE 2008

- Qualified for Automotive Applications
- Complete PWM Power Control Circuitry
- Completely Synchronized Operation
- Internal Undervoltage Lockout Protection
- Wide Supply Voltage Range
- Internal Short-Circuit Protection
- Oscillator Frequency . . . 500 kHz Max
- Variable Dead Time Provides Control Over Total Range
- Internal Regulator Provides a Stable 2.5-V Reference Supply
- Available in Q-Temp Automotive HighRel Automotive Applications Configuration Control / Print Support Qualification to Automotive Standards

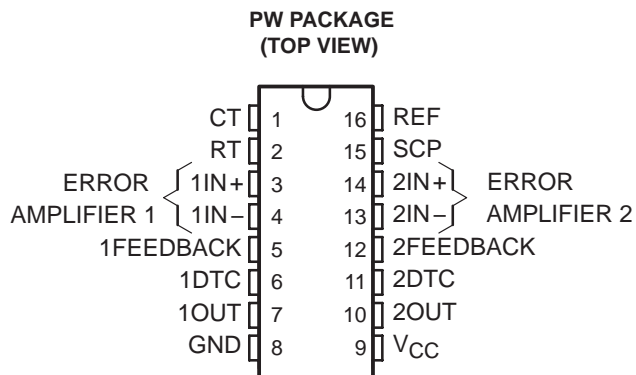

description

The TL1451A incorporates on a single monolithic chip all the functions required in the construction of two pulse-width-modulation (PWM) control circuits. Designed primarily for power-supply control, the TL1451A contains an on-chip 2.5-V regulator, two error amplifiers, an adjustable oscillator, two dead-time comparators, undervoltage lockout circuitry, and dual common-emitter output transistor circuits.

The uncommitted output transistors provide common-emitter output capability for each controller. The internal amplifiers exhibit a common-mode voltage range from 1.04 V to 1.45 V. The dead-time control (DTC) comparator has no offset unless externally altered and can provide 0% to 100% dead time. The on-chip oscillator can be operated by terminating RT and CT. During low V_{CC} conditions, the undervoltage lockout control circuit feature locks the outputs off until the internal circuitry is operational.

The TL1451A is characterized for operation from -40°C to 125°C .

AVAILABLE OPTIONS[†]

T _A	PACKAGED DEVICES [‡]
	TSSOP (PW) [§]
-40°C to 125°C	TL1451AQPWRQ1

[†] For the most current package and ordering information, see the Package Option Addendum at the end of this document, or see the TI web site at <http://www.ti.com>.

[‡] Package drawings, thermal data, and symbolization are available at <http://www.ti.com/packaging>.

[§] The PW package is only available left-end taped and reeled.



Please be aware that an important notice concerning availability, standard warranty, and use in critical applications of Texas Instruments semiconductor products and disclaimers thereto appears at the end of this data sheet.

PRODUCTION DATA information is current as of publication date. Products conform to specifications per the terms of Texas Instruments standard warranty. Production processing does not necessarily include testing of all parameters.

 **TEXAS
INSTRUMENTS**
www.ti.com

Copyright © 2008, Texas Instruments Incorporated
On products compliant to MIL-PRF-38535, all parameters are tested unless otherwise noted. On all other products, production processing does not necessarily include testing of all parameters.

TL1451A-Q1 DUAL PULSE-WIDTH-MODULATION CONTROL CIRCUITS

SGLS304A – JUNE 2005 – REVISED JUNE 2008

functional block diagram

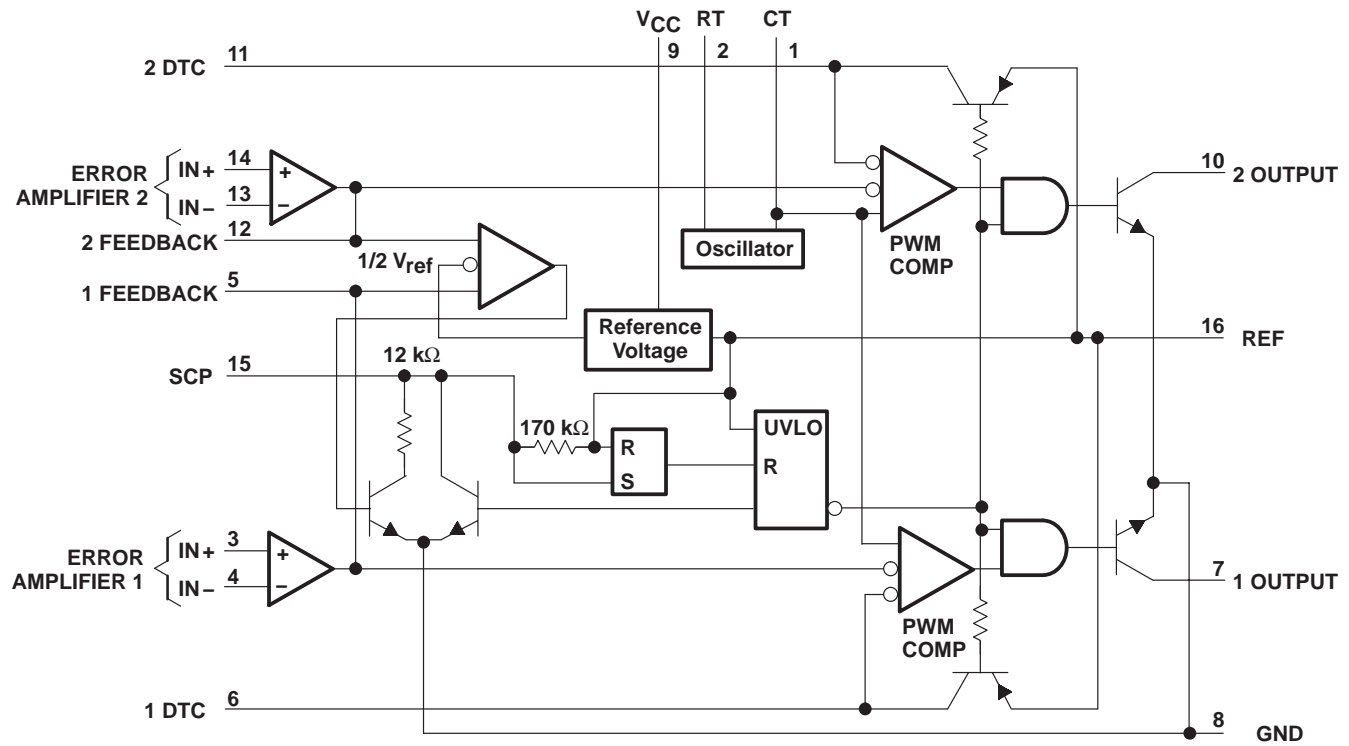

COMPONENT COUNT

Resistors	65
Capacitors	8
Transistors	105
JFETs	18

TL1451A-Q1

DUAL PULSE-WIDTH-MODULATION CONTROL CIRCUITS

SGLS304A – JUNE 2005 – REVISED JUNE 2008

absolute maximum ratings over operating free-air temperature range†

Supply voltage, V_{CC}	51 V
Amplifier input voltage, V_I	20 V
Collector output voltage, V_O	51 V
Collector output current, I_O	21 mA
Continuous power total dissipation	See Dissipation Rating Table
Operating free-air temperature range, T_A	-40°C to 125°C
Storage temperature range, T_{stg}	-65°C to 150°C
Lead temperature 1,6 mm (1/16 inch) from case for 10 seconds	260°C

† Stresses beyond those listed under “absolute maximum ratings” may cause permanent damage to the device. These are stress ratings only, and functional operation of the device at these or any other conditions beyond those indicated under “recommended operating conditions” is not implied. Exposure to absolute-maximum-rated conditions for extended periods may affect device reliability.

DISSIPATION RATING TABLE

PACKAGE	$T_A \leq 25^\circ\text{C}$ POWER RATING	DERATING FACTOR ABOVE $T_A = 25^\circ\text{C}$	$T_A = 70^\circ\text{C}$ POWER RATING	$T_A = 85^\circ\text{C}$ POWER RATING	$T_A = 125^\circ\text{C}$ POWER RATING
PW	838 mW	6.7 mW/°C	536 mW	436 mW	168 mW

recommended operating conditions

	MIN	MAX	UNIT
Supply voltage, V_{CC}	3.6	50	V
Amplifier input voltage, V_I	1.05	1.45	V
Collector output voltage, V_O		50	V
Collector output current, I_O		20	mA
Current into feedback terminal		45	μA
Feedback resistor, R_F	100		k Ω
Timing capacitor, C_T	150	15000	pF
Timing resistor, R_T	5.1	100	k Ω
Oscillator frequency	1	500	kHz
Operating free-air temperature, T_A	-40	125	°C

TL1451A-Q1

DUAL PULSE-WIDTH-MODULATION CONTROL CIRCUITS

SGLS304A – JUNE 2005 – REVISED JUNE 2008

electrical characteristics over recommended operating free-air temperature range, $V_{CC} = 6\text{ V}$, $f = 200\text{ kHz}$ (unless otherwise noted)

reference section

PARAMETER	TEST CONDITIONS		TL1451AQ			UNIT
			MIN	TYP†	MAX	
Output voltage (pin 16)	$I_O = 1\text{ mA}$	$T_A = 25^\circ\text{C}$	2.4	2.5	2.6	V
		$T_A = \text{MIN and } 125^\circ\text{C}$	2.35	2.46	2.65	
Output voltage change with temperature			-0.63%		$\pm 4\%^\ddagger$	
Input voltage regulation	$V_{CC} = 3.6\text{ V to } 40\text{ V}$	$T_A = 25^\circ\text{C}$		2.0	12.5	mV
		$T_A = 125^\circ\text{C}$		0.7	15	
		$T_A = \text{MIN}$		0.3	30	
Output voltage regulation	$I_O = 0.1\text{ mA to } 1\text{ mA}$	$T_A = 25^\circ\text{C}$		1	7.5	mV
		$T_A = 125^\circ\text{C}$		0.3	14	
		$T_A = \text{MIN}$		0.3	20	
Short-circuit output current	$V_O = 0$		3	10	30	mA

† All typical values are at $T_A = 25^\circ\text{C}$ unless otherwise indicated.

‡ These parameters are not production tested.

undervoltage lockout section

PARAMETER	TEST CONDITIONS		TL1451AQ			UNIT
			MIN	TYP†	MAX	
Upper threshold voltage (V_{CC})		$T_A = 25^\circ\text{C}$		2.72		V
		$T_A = 125^\circ\text{C}$		1.7		
		$T_A = \text{MIN}$		3.15		
Lower threshold voltage (V_{CC})		$T_A = 25^\circ\text{C}$		2.6		V
		$T_A = 125^\circ\text{C}$		1.65		
		$T_A = \text{MIN}$		3.09		
Hysteresis (V_{CC})		$T_A = 25^\circ\text{C}$	80	120		mV
		$T_A = 125^\circ\text{C}$	10	50		
		$T_A = \text{MIN}$	10	60		
Reset threshold voltage (V_{CC})		$T_A = 25^\circ\text{C}$		1.5		V
		$T_A = 125^\circ\text{C}$		0.95		
		$T_A = \text{MIN}$		1.5		

† All typical values are at $T_A = 25^\circ\text{C}$ unless otherwise indicated.

TL1451A-Q1

DUAL PULSE-WIDTH-MODULATION CONTROL CIRCUITS

SGLS304A – JUNE 2005 – REVISED JUNE 2008

short-circuit protection control section

PARAMETER	TEST CONDITIONS	TL1451AQ			UNIT
		MIN	TYP†	MAX	
Input threshold voltage (SCP)	$T_A = 25^\circ\text{C}$	650	700	750	mV
	$T_A = 125^\circ\text{C}$	400	478	650	
	$T_A = \text{MIN}$	800	880	950	
Standby voltage (SCP)		140	185	230	mV
Latched input voltage (SCP)	$T_A = 25^\circ\text{C}$		60	120	mV
	$T_A = 125^\circ\text{C}$		70	120	
	$T_A = \text{MIN}$		60	120	
Equivalent timing resistance			170		k Ω
Comparator threshold voltage (FEEDBACK)			1.18		V

† All typical values are at $T_A = 25^\circ\text{C}$ unless otherwise indicated.

oscillator section

PARAMETER	TEST CONDITIONS	TL1451AQ			UNIT
		MIN	TYP†	MAX	
Frequency	$C_T = 330\text{ pF}$, $R_T = 10\text{ k}\Omega$	$T_A = 25^\circ\text{C}$	200		kHz
		$T_A = 125^\circ\text{C}$	195		
		$T_A = \text{MIN}$	193		
Standard deviation of frequency	$C_T = 330\text{ pF}$, $R_T = 10\text{ k}\Omega$		2%		
Frequency change with voltage	$V_{CC} = 3.6\text{ V to }40\text{ V}$	$T_A = 25^\circ\text{C}$	1%		
		$T_A = 125^\circ\text{C}$	1%		
		$T_A = \text{MIN}$	3%		
Frequency change with temperature			1.37%	$\pm 10\%^\ddagger$	

† All typical values are at $T_A = 25^\circ\text{C}$ unless otherwise indicated.

‡ These parameters are not production tested.

dead-time control section

PARAMETER	TEST CONDITIONS	TL1451AQ			UNIT
		MIN	TYP†	MAX	
Input bias current (DTC)	$T_A = 25^\circ\text{C}$			1	μA
	$T_A = \text{MIN and } 125^\circ\text{C}$			3	
Latch mode (source) current (DTC)		-80	-145		μA
Latched input voltage (DTC)	$T_A = 25^\circ\text{C}$	2.3		V	
	$T_A = 125^\circ\text{C}$	2.22	2.32		
	$T_A = \text{MIN}$	2.28	2.4		
Input threshold voltage at $f = 10\text{ kHz}$ (DTC)	Zero duty cycle		2.05	2.25 [‡]	V
	Maximum duty cycle	1.2 [‡]	1.45		

† All typical values are at $T_A = 25^\circ\text{C}$ unless otherwise indicated.

‡ These parameters are not production tested.

TL1451A-Q1

DUAL PULSE-WIDTH-MODULATION CONTROL CIRCUITS

SGLS304A – JUNE 2005 – REVISED JUNE 2008

error-amplifier section

PARAMETER	TEST CONDITIONS	TL1451AQ			UNIT
		MIN	TYP†	MAX	
Input offset voltage	V_O (FEEDBACK) = 1.25 V	$T_A = 25^\circ\text{C}$	±7		mV
		$T_A = 125^\circ\text{C}$	±10		
		$T_A = \text{MIN}$	±12		
Input offset current	V_O (FEEDBACK) = 1.25 V	$T_A = 25^\circ\text{C}$	±100		nA
		$T_A = 125^\circ\text{C}$	±100		
		$T_A = \text{MIN}$	±200		
Input bias current	V_O (FEEDBACK) = 1.25 V	$T_A = 25^\circ\text{C}$	160	500	nA
		$T_A = 125^\circ\text{C}$	100	500	
		$T_A = \text{MIN}$	142	700	
Common-mode input voltage range	$V_{CC} = 3.6 \text{ V to } 40 \text{ V}$	1.05 to 1.45			V
Open-loop voltage amplification	$R_F = 200 \text{ k}\Omega$	$T_A = 25^\circ\text{C}$	70	80	dB
		$T_A = 125^\circ\text{C}$	70	80	
		$T_A = \text{MIN}$	64	80	
Unity-gain bandwidth		1.5		MHz	
Common-mode rejection ratio		60	80	dB	
Positive output voltage swing		2		V	
Negative output voltage swing		1		V	
Output (sink) current (FEEDBACK)	$V_{ID} = -0.1 \text{ V}, V_O = 1.25 \text{ V}$	$T_A = 25^\circ\text{C}$	0.5	1.6	mA
		$T_A = 125^\circ\text{C}$	0.4	1.8	
		$T_A = \text{MIN}$	0.3	1.7	
Output (source) current (FEEDBACK)	$V_{ID} = 0.1 \text{ V}, V_O = 1.25 \text{ V}$	$T_A = 25^\circ\text{C}$	-45	-70	μA
		$T_A = 125^\circ\text{C}$	-25	-50	
		$T_A = \text{MIN}$	-15	-70	

† All typical values are at $T_A = 25^\circ\text{C}$ unless otherwise indicated.

output section

PARAMETER	TEST CONDITIONS	TL1451AQ			UNIT
		MIN	TYP†	MAX	
Collector off-state current	$V_O = 50 \text{ V}$			10	μA
Output saturation voltage	$T_A = 25^\circ\text{C}$	1.2		2	V
	$T_A = 125^\circ\text{C}$	1.6		2.4	
	$T_A = \text{MIN}$	1.36		2.2	
Short-circuit output current	$V_O = 6 \text{ V}$	90			mA

† All typical values are at $T_A = 25^\circ\text{C}$ unless otherwise indicated.

pwm comparator section

PARAMETER	TEST CONDITIONS	TL1451AQ			UNIT
		MIN	TYP†	MAX	
Input threshold voltage at $f = 10 \text{ kHz}$ (FEEDBACK)	Zero duty cycle	2.05		2.25‡	V
	Maximum duty cycle	1.2‡	1.45		

† All typical values are at $T_A = 25^\circ\text{C}$ unless otherwise indicated.

‡ These parameters are not production tested.

TL1451A-Q1 DUAL PULSE-WIDTH-MODULATION CONTROL CIRCUITS

SGLS304A – JUNE 2005 – REVISED JUNE 2008

total device

PARAMETER	TEST CONDITIONS	TL1451AQ		UNIT	
		MIN	TYP†		MAX
Standby supply current	Off-state		1.3	1.8	mA
Average supply current	$R_T = 10\text{ k}\Omega$		1.7	2.4	mA

† All typical values are at $T_A = 25^\circ\text{C}$ unless otherwise indicated.

PARAMETER MEASUREMENT INFORMATION

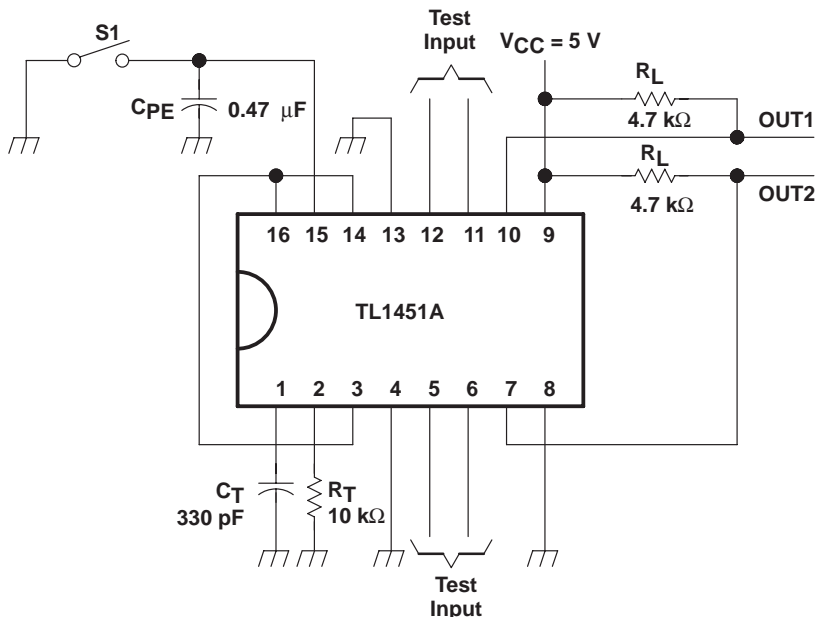
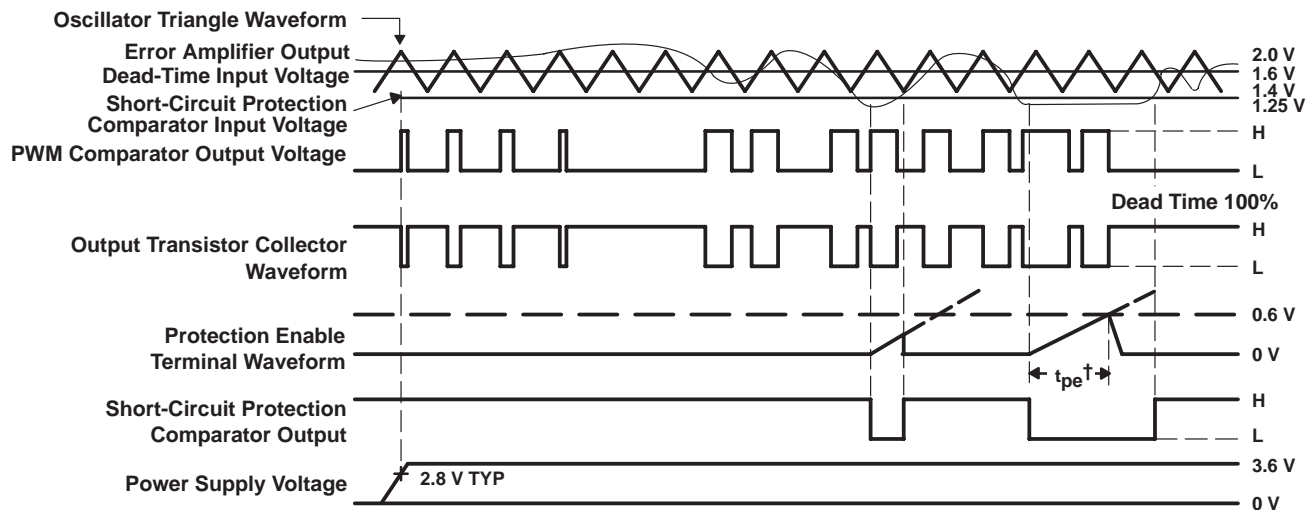

Figure 1. Test Circuit



† Protection Enable Time, $t_{pe} = (0.051 \times 10^6 \times C_{pe})$ in seconds

Figure 2. TL1451A Timing Diagram

TL1451A-Q1 DUAL PULSE-WIDTH-MODULATION CONTROL CIRCUITS

SGLS304A – JUNE 2005 – REVISED JUNE 2008

TYPICAL CHARACTERISTICS

TRIANGLE OSCILLATOR FREQUENCY
vs
TIMING RESISTANCE

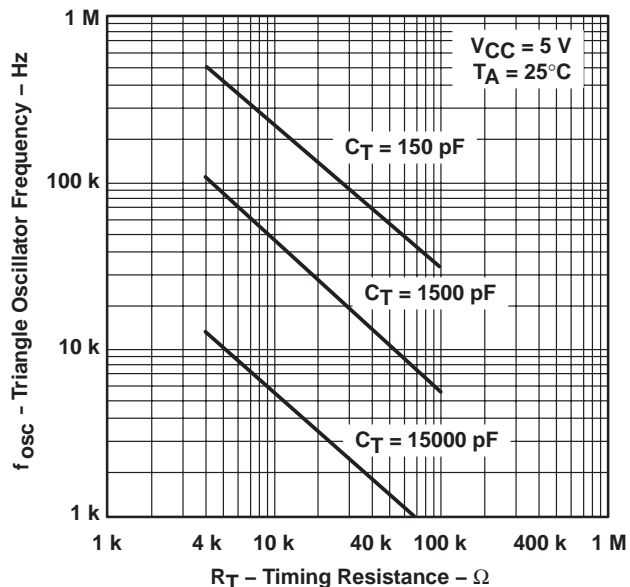

Figure 3

OSCILLATOR FREQUENCY VARIATION
vs
FREE-AIR TEMPERATURE

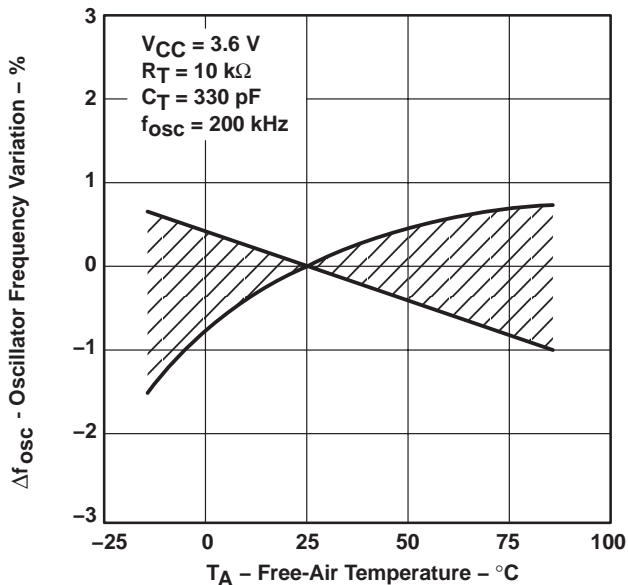

Figure 4

TRIANGLE WAVEFORM SWING VOLTAGE
vs
TIMING CAPACITANCE

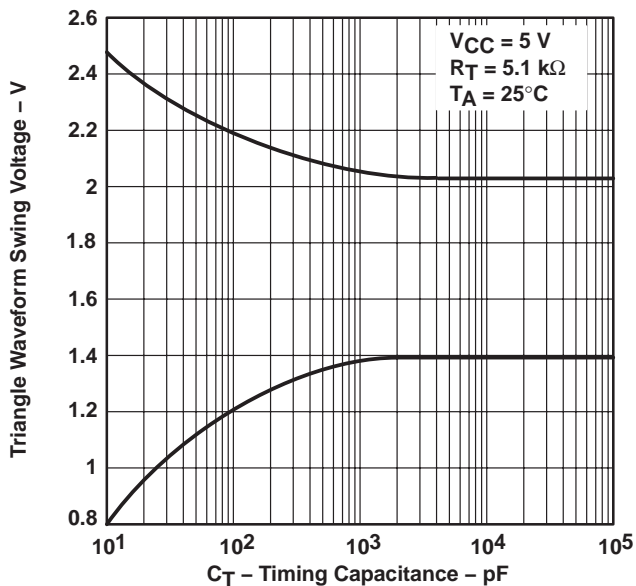

Figure 5

TRIANGLE WAVEFORM PERIOD
vs
TIMING CAPACITANCE

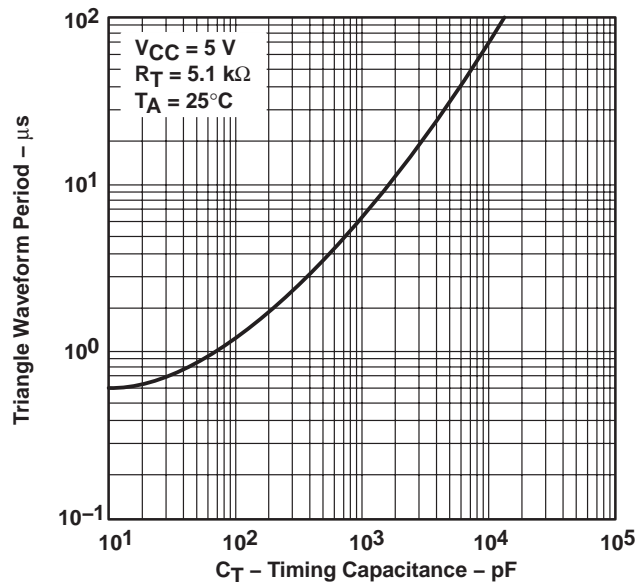

Figure 6

TYPICAL CHARACTERISTICS

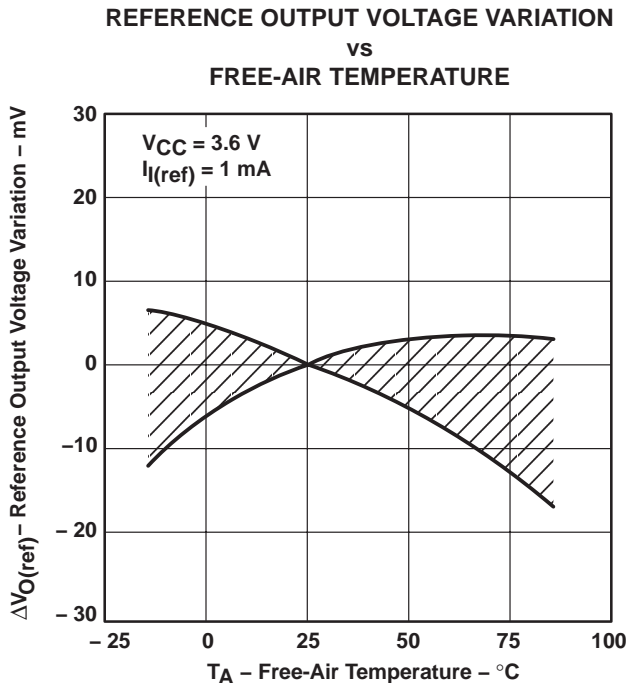

Figure 7

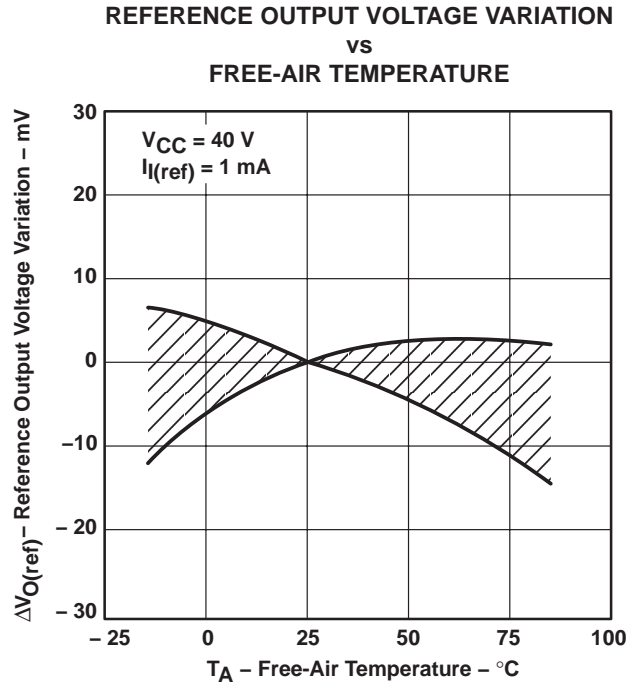

Figure 8

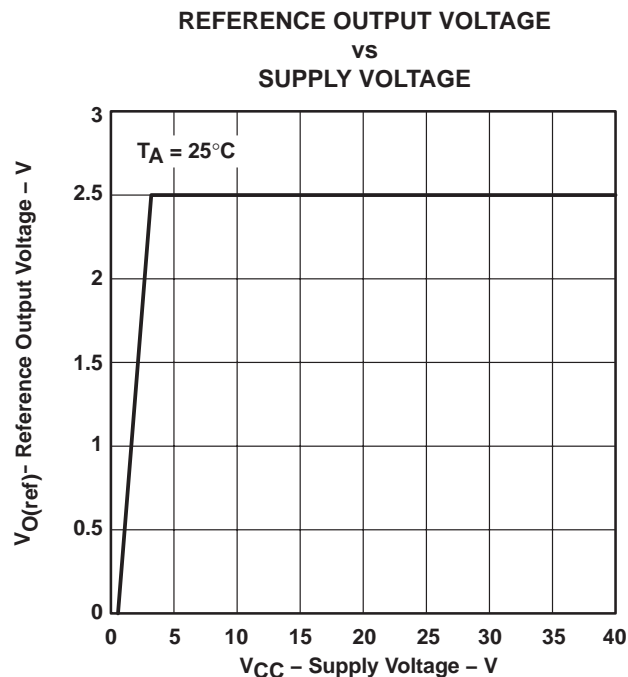

Figure 9

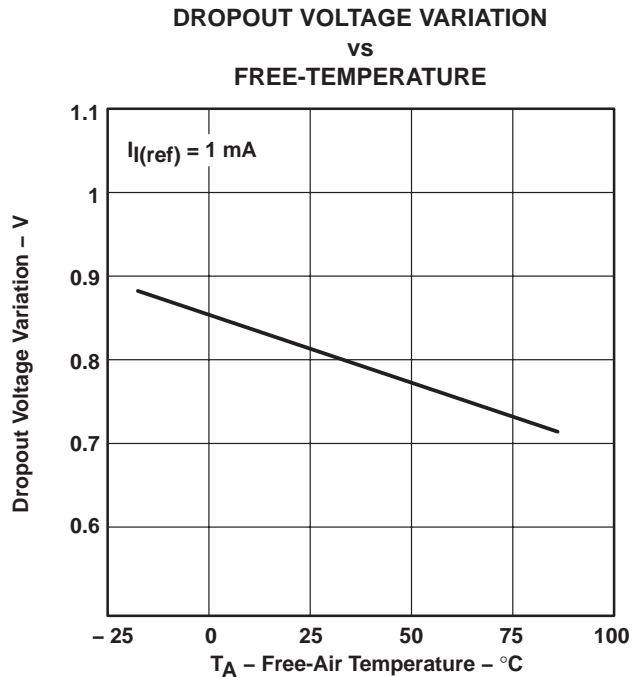

Figure 10

TL1451A-Q1 DUAL PULSE-WIDTH-MODULATION CONTROL CIRCUITS

SGLS304A – JUNE 2005 – REVISED JUNE 2008

TYPICAL CHARACTERISTICS

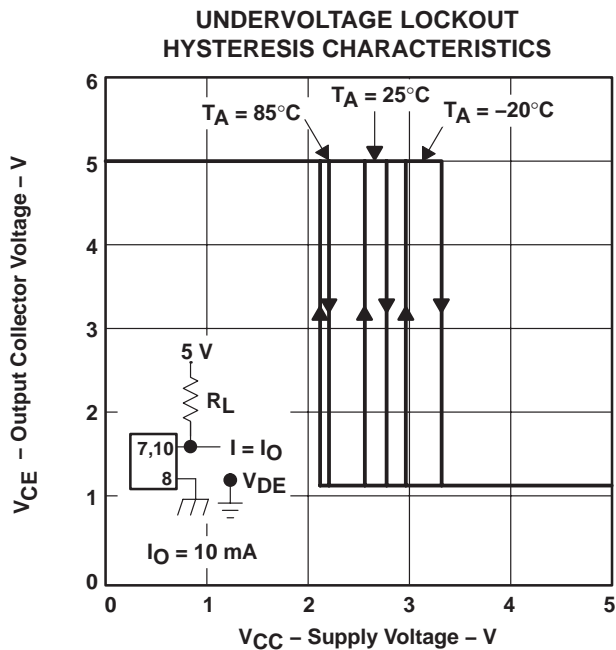

Figure 11

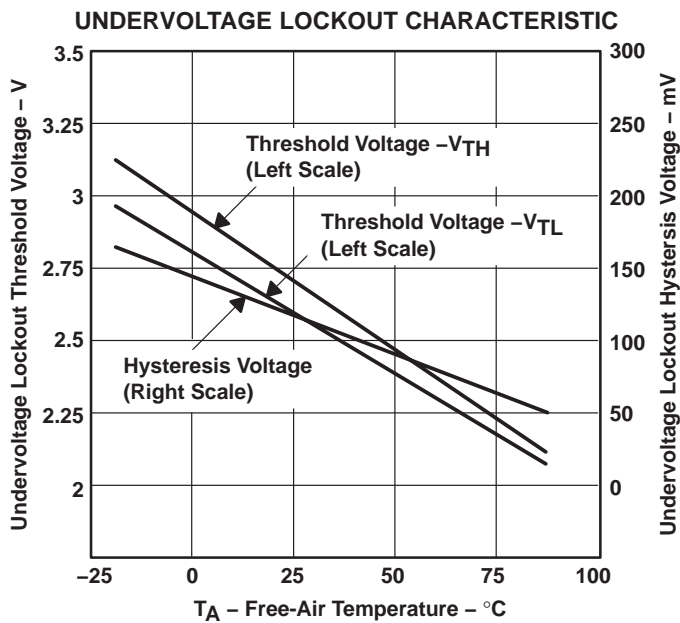

Figure 12

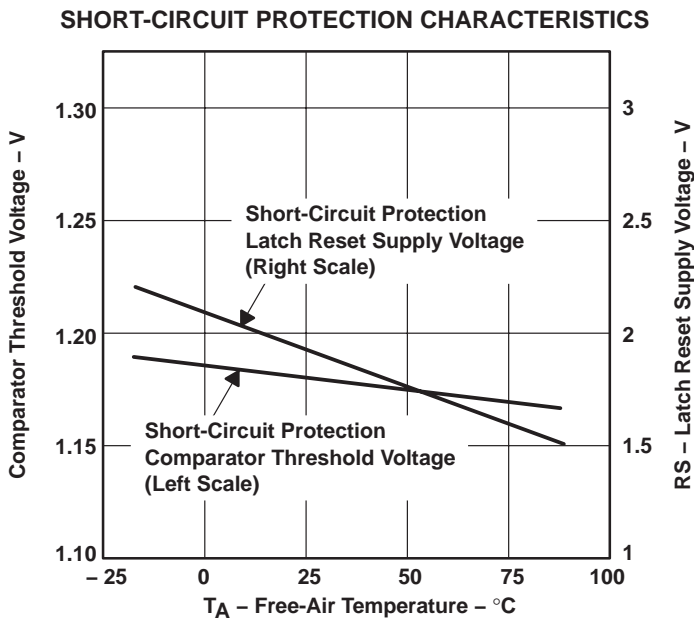

Figure 13

TYPICAL CHARACTERISTICS

**PROTECTION ENABLE TIME
vs
PROTECTION ENABLE CAPACITANCE**

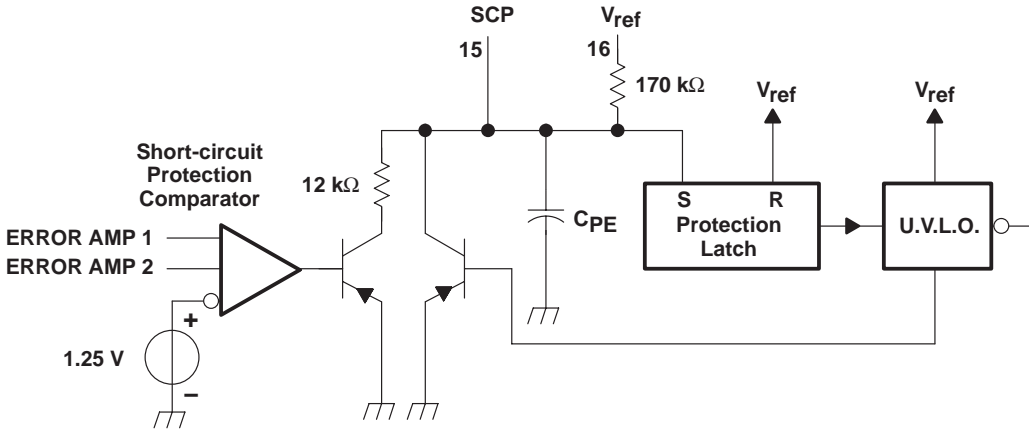
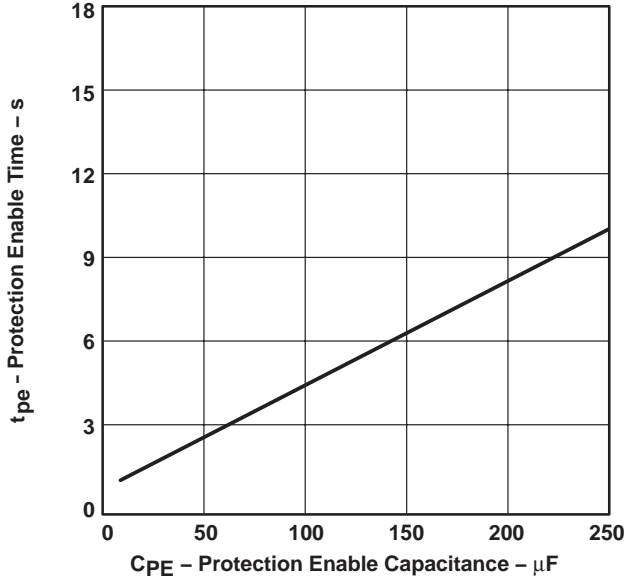

Figure 14

TL1451A-Q1

DUAL PULSE-WIDTH-MODULATION CONTROL CIRCUITS

SGLS304A – JUNE 2005 – REVISED JUNE 2008

TYPICAL CHARACTERISTICS

ERROR AMP MAXIMUM OUTPUT VOLTAGE SWING
vs
FREQUENCY

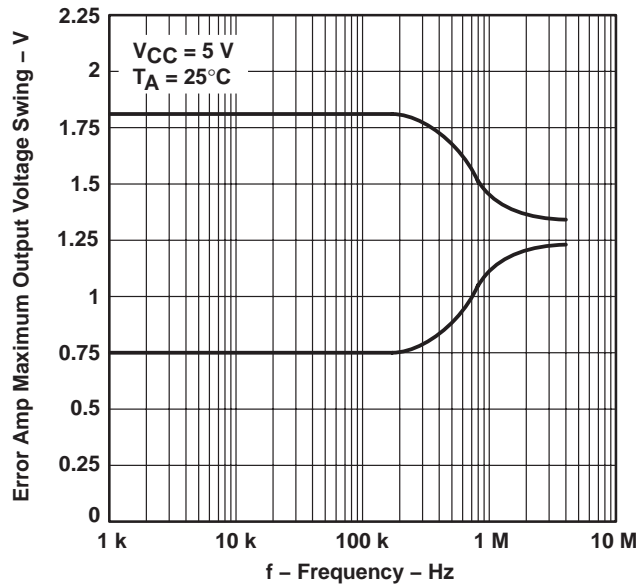

Figure 15

OPEN-LOOP VOLTAGE AMPLIFICATION
vs
FREQUENCY

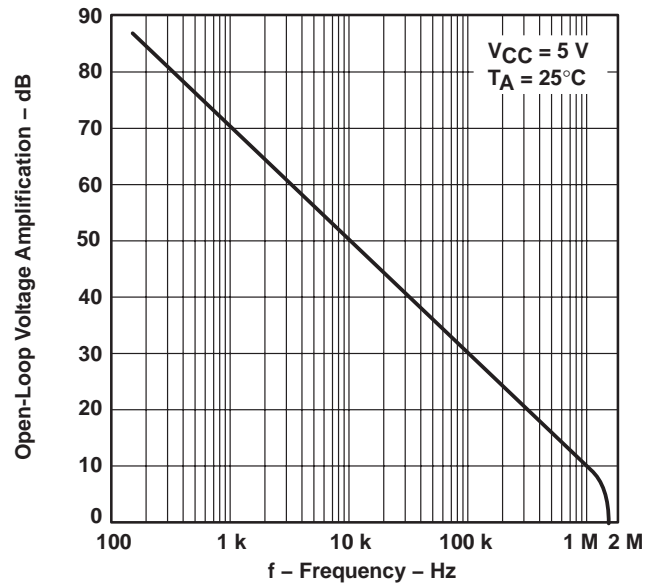

Figure 16

GAIN (AMPLIFIER IN
UNITY-GAIN CONFIGURATION)
vs
FREQUENCY

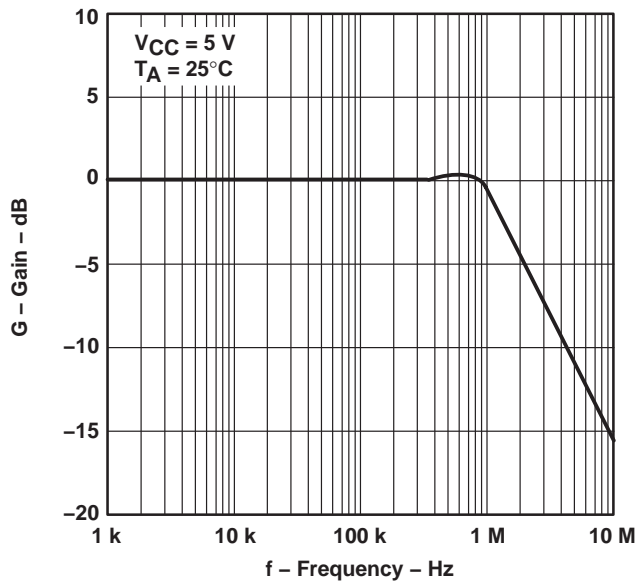
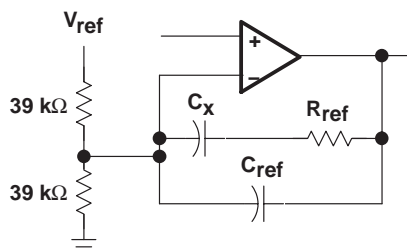
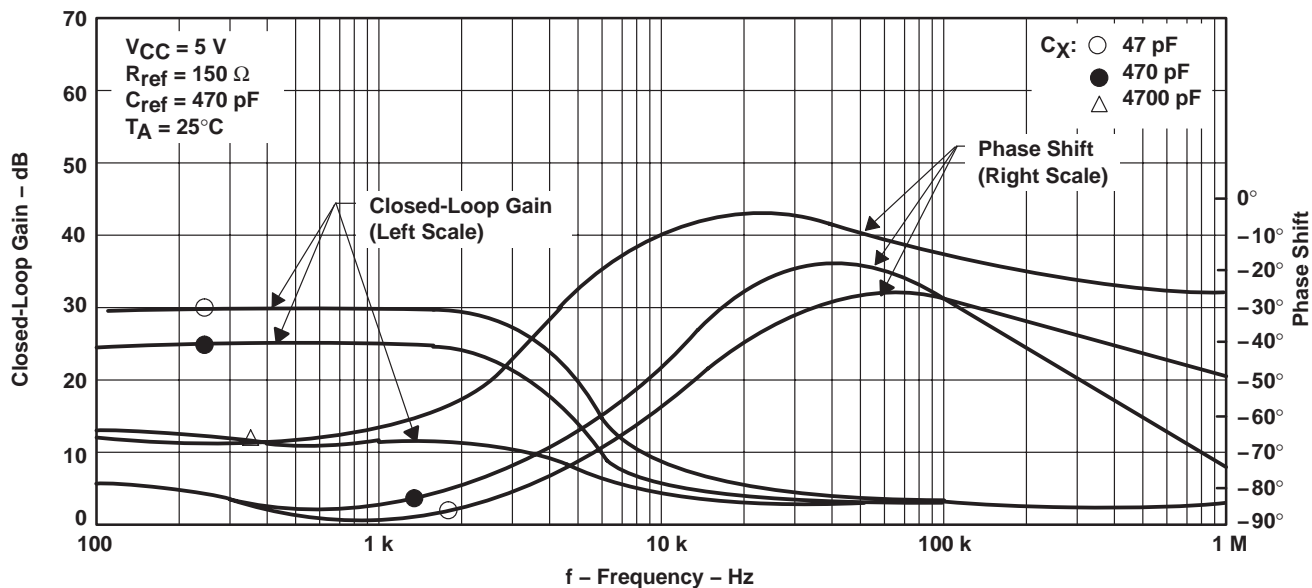

Figure 17

TYPICAL CHARACTERISTICS

CLOSED-LOOP GAIN AND PHASE SHIFT VS FREQUENCY



Test Circuit

Figure 18

TL1451A-Q1

DUAL PULSE-WIDTH-MODULATION CONTROL CIRCUITS

SGLS304A – JUNE 2005 – REVISED JUNE 2008

TYPICAL CHARACTERISTICS

CLOSED-LOOP GAIN AND PHASE SHIFT vs FREQUENCY

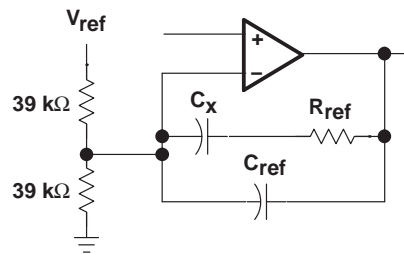
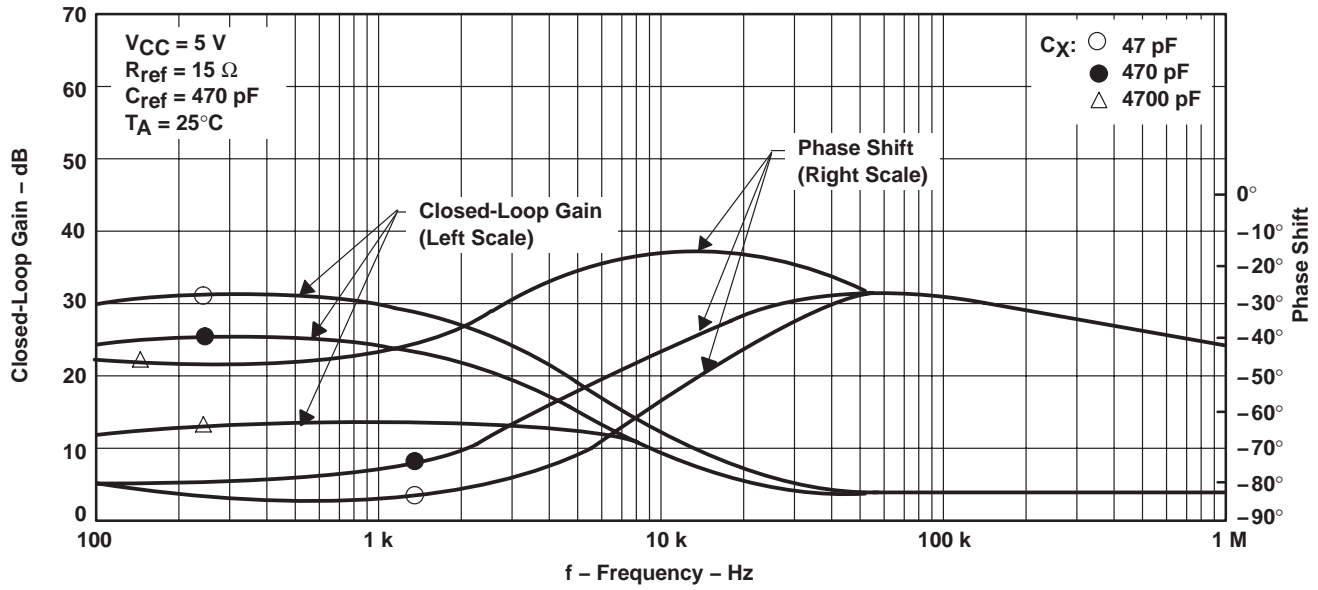

Test Circuit

Figure 19

TYPICAL CHARACTERISTICS

CLOSED-LOOP GAIN AND PHASE SHIFT
 VS
 FREQUENCY

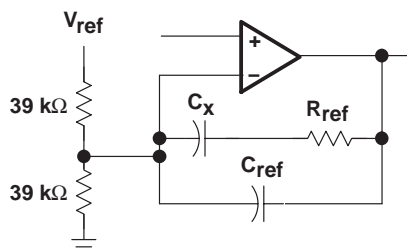
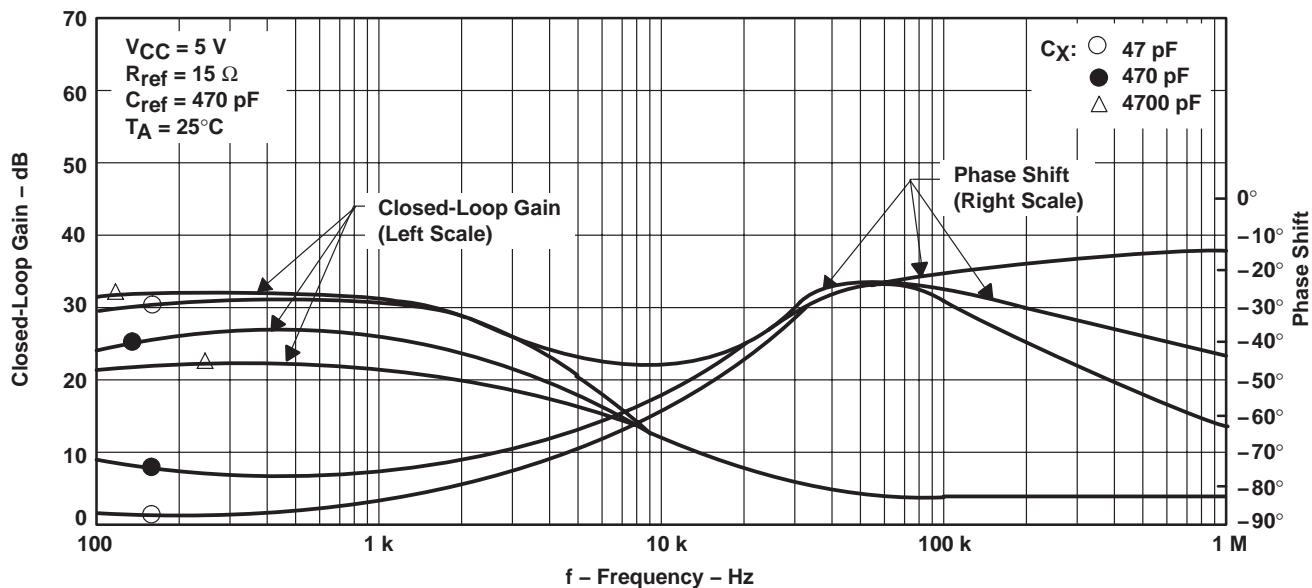

Test Circuit

Figure 20

TL1451A-Q1 DUAL PULSE-WIDTH-MODULATION CONTROL CIRCUITS

SGLS304A – JUNE 2005 – REVISED JUNE 2008

TYPICAL CHARACTERISTICS CLOSED-LOOP GAIN AND PHASE SHIFT vs FREQUENCY

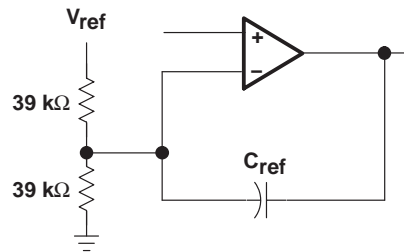
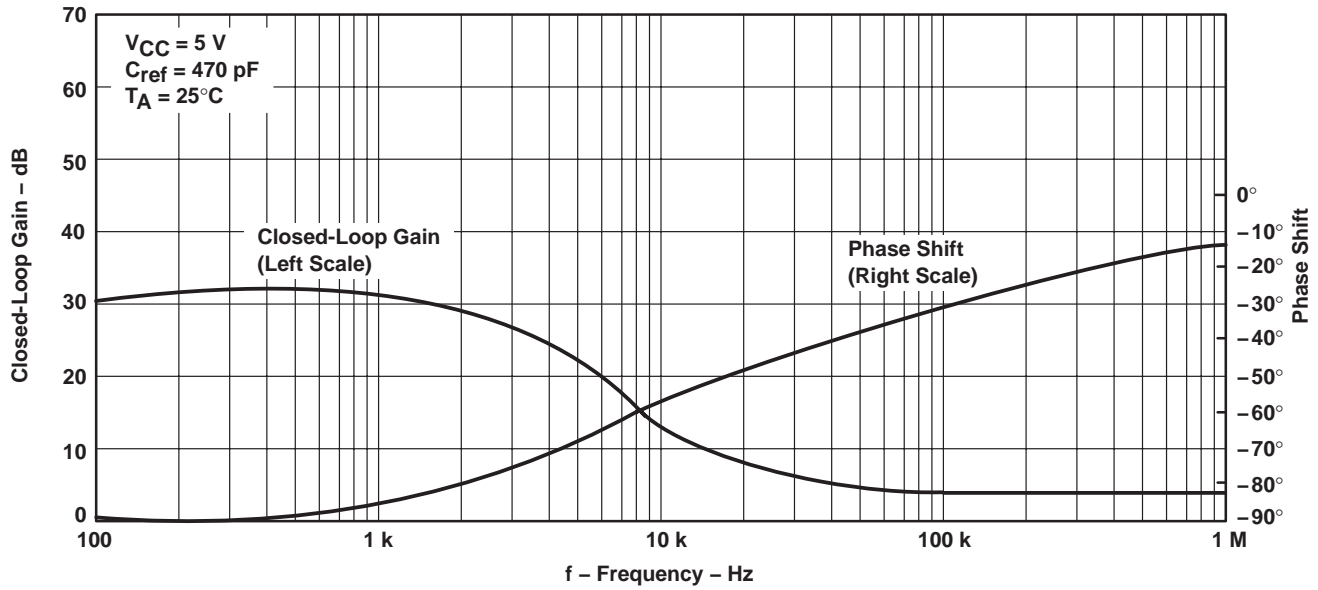

Test Circuit

Figure 21

TYPICAL CHARACTERISTICS

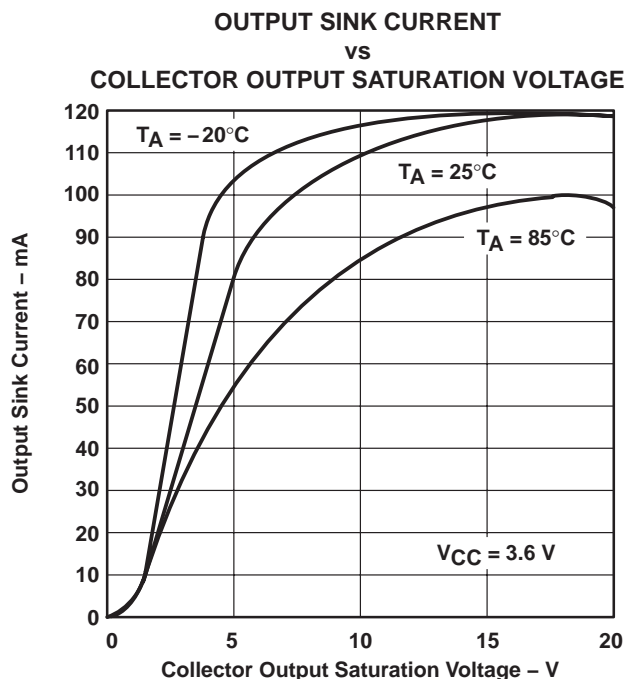

Figure 22

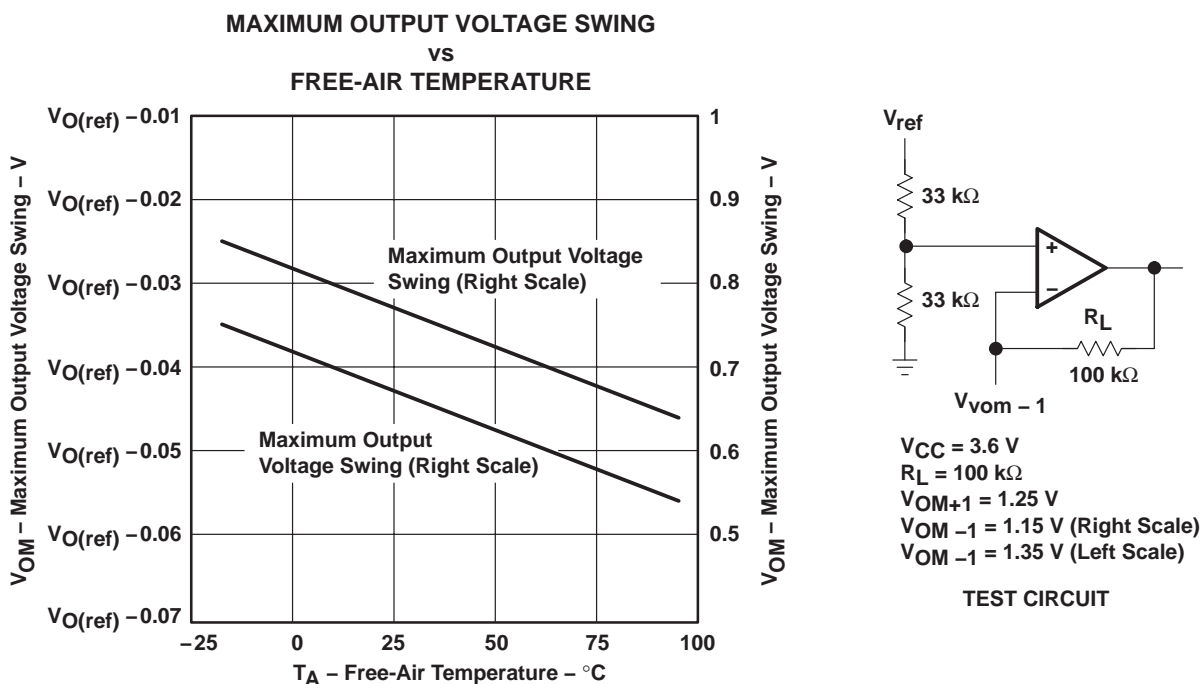
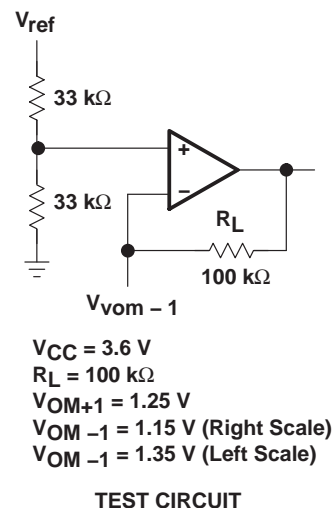

Figure 23



TL1451A-Q1

DUAL PULSE-WIDTH-MODULATION CONTROL CIRCUITS

SGLS304A – JUNE 2005 – REVISED JUNE 2008

TYPICAL CHARACTERISTICS

OUTPUT TRANSISTOR ON DUTY CYCLE
vs
DEAD-TIME INPUT VOLTAGE

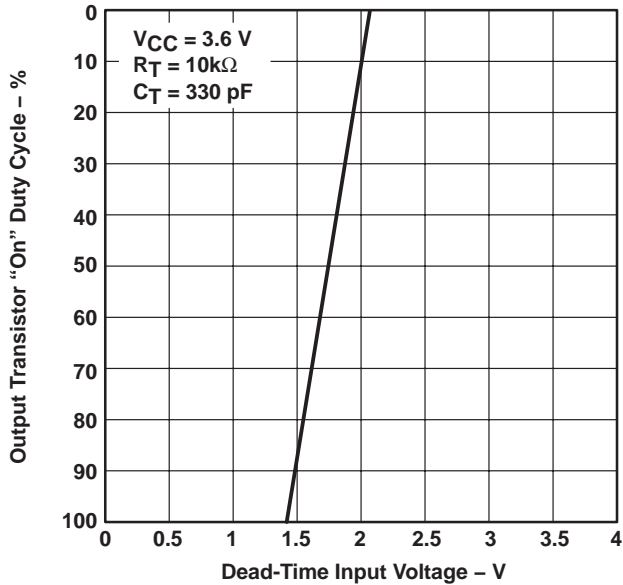

Figure 24

STANDBY CURRENT
vs
SUPPLY VOLTAGE

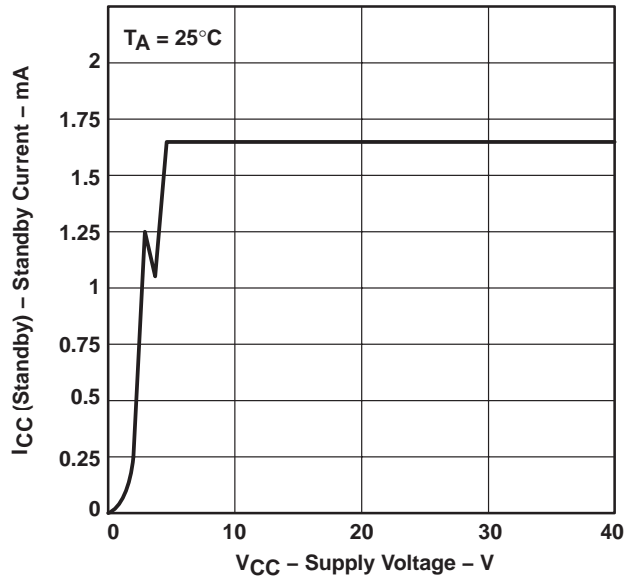

Figure 25

STANDBY CURRENT
vs
FREE-AIR TEMPERATURE

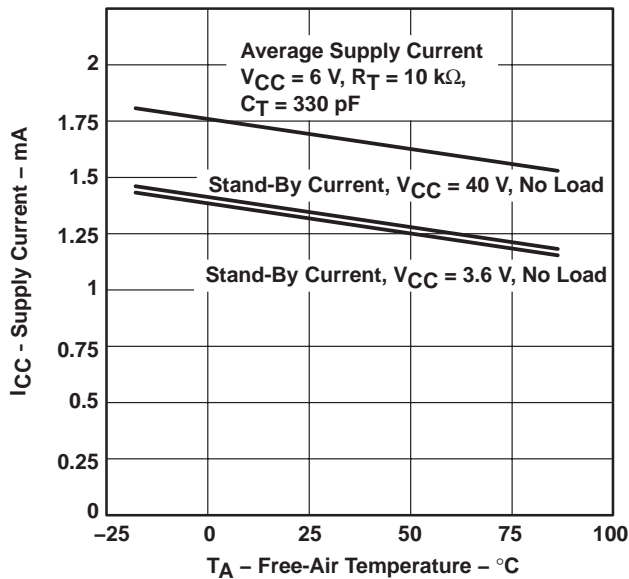

Figure 26

MAXIMUM CONTINUOUS POWER DISSIPATION
vs
FREE-AIR TEMPERATURE

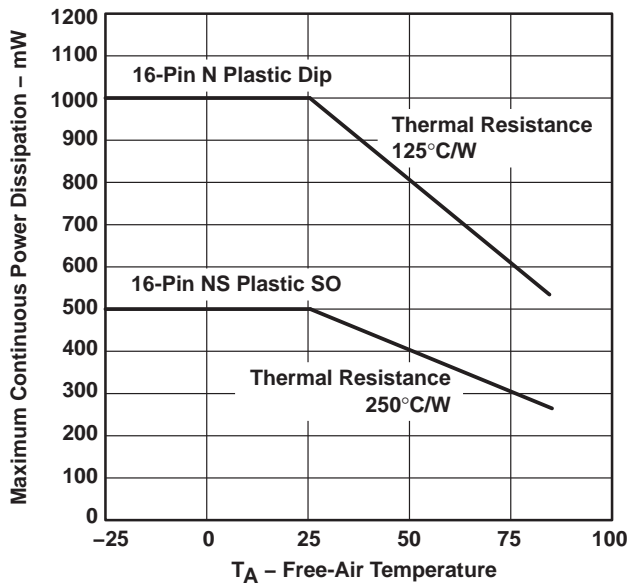
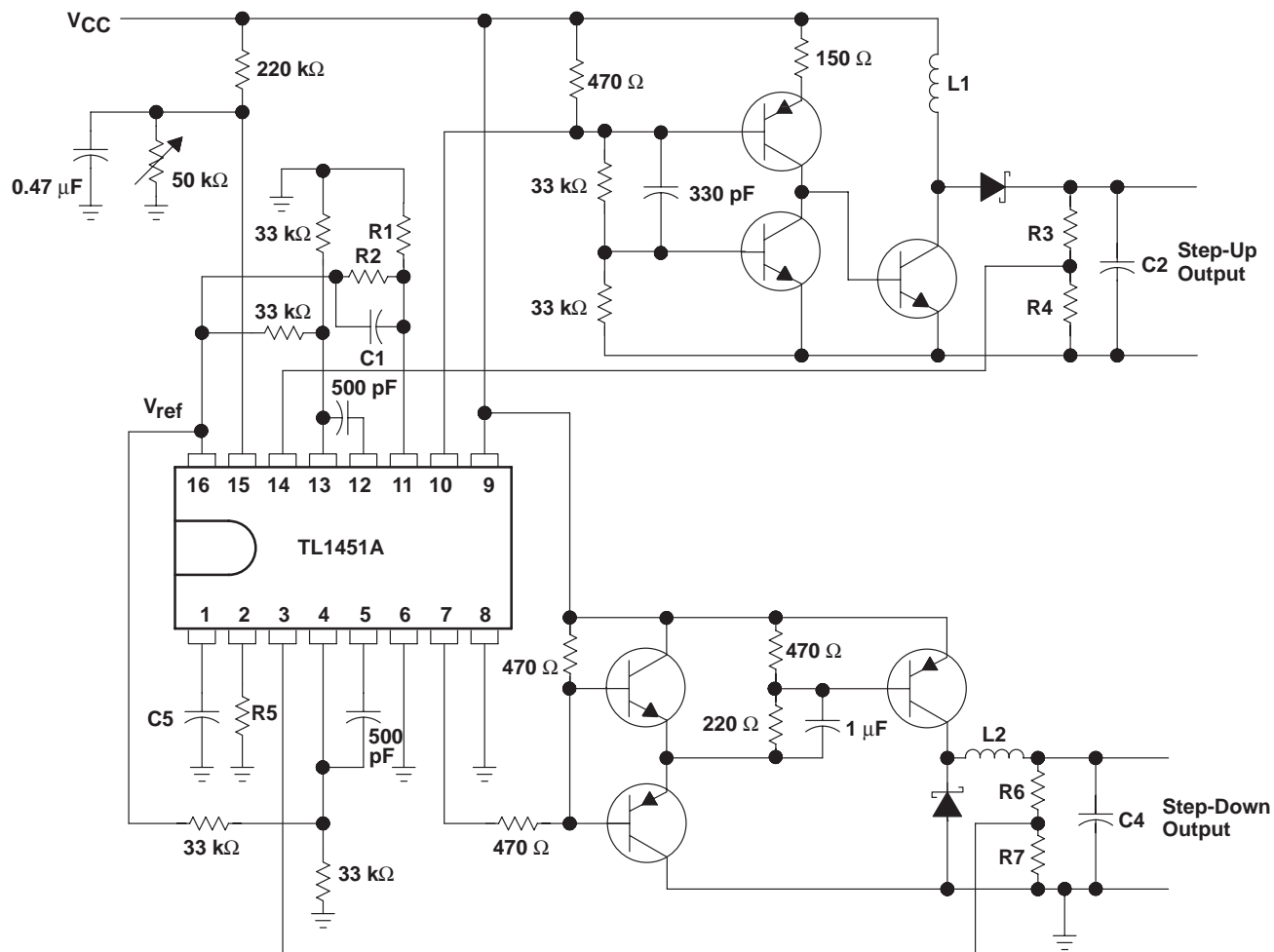

Figure 27

APPLICATION INFORMATION



NOTE A: Values for R1 through R7, C1 through C4, and L1 and L2 depend upon individual application.

Figure 28. High-Speed Dual Switching Regulator

PACKAGING INFORMATION

Orderable Device	Status ⁽¹⁾	Package Type	Package Drawing	Pins	Package Qty	Eco Plan ⁽²⁾	Lead/Ball Finish	MSL Peak Temp ⁽³⁾
TL1451AQPWRG4Q1	ACTIVE	TSSOP	PW	16	2000	Green (RoHS & no Sb/Br)	CU NIPDAU	Level-1-260C-UNLIM
TL1451AQPWRQ1	ACTIVE	TSSOP	PW	16	2000	Pb-Free (RoHS)	CU NIPDAU	Level-1-250C-UNLIM

⁽¹⁾ The marketing status values are defined as follows:

ACTIVE: Product device recommended for new designs.

LIFEBUY: TI has announced that the device will be discontinued, and a lifetime-buy period is in effect.

NRND: Not recommended for new designs. Device is in production to support existing customers, but TI does not recommend using this part in a new design.

PREVIEW: Device has been announced but is not in production. Samples may or may not be available.

OBsolete: TI has discontinued the production of the device.

⁽²⁾ Eco Plan - The planned eco-friendly classification: Pb-Free (RoHS), Pb-Free (RoHS Exempt), or Green (RoHS & no Sb/Br) - please check <http://www.ti.com/productcontent> for the latest availability information and additional product content details.

TBD: The Pb-Free/Green conversion plan has not been defined.

Pb-Free (RoHS): TI's terms "Lead-Free" or "Pb-Free" mean semiconductor products that are compatible with the current RoHS requirements for all 6 substances, including the requirement that lead not exceed 0.1% by weight in homogeneous materials. Where designed to be soldered at high temperatures, TI Pb-Free products are suitable for use in specified lead-free processes.

Pb-Free (RoHS Exempt): This component has a RoHS exemption for either 1) lead-based flip-chip solder bumps used between the die and package, or 2) lead-based die adhesive used between the die and leadframe. The component is otherwise considered Pb-Free (RoHS compatible) as defined above.

Green (RoHS & no Sb/Br): TI defines "Green" to mean Pb-Free (RoHS compatible), and free of Bromine (Br) and Antimony (Sb) based flame retardants (Br or Sb do not exceed 0.1% by weight in homogeneous material)

⁽³⁾ MSL, Peak Temp. -- The Moisture Sensitivity Level rating according to the JEDEC industry standard classifications, and peak solder temperature.

Important Information and Disclaimer:The information provided on this page represents TI's knowledge and belief as of the date that it is provided. TI bases its knowledge and belief on information provided by third parties, and makes no representation or warranty as to the accuracy of such information. Efforts are underway to better integrate information from third parties. TI has taken and continues to take reasonable steps to provide representative and accurate information but may not have conducted destructive testing or chemical analysis on incoming materials and chemicals. TI and TI suppliers consider certain information to be proprietary, and thus CAS numbers and other limited information may not be available for release.

In no event shall TI's liability arising out of such information exceed the total purchase price of the TI part(s) at issue in this document sold by TI to Customer on an annual basis.

OTHER QUALIFIED VERSIONS OF TL1451A-Q1 :

- Catalog: [TL1451A](#)
- Enhanced Product: [TL1451A-EP](#)
- Military: [TL1451AM](#)

NOTE: Qualified Version Definitions:

- Catalog - TI's standard catalog product
- Enhanced Product - Supports Defense, Aerospace and Medical Applications
- Military - QML certified for Military and Defense Applications

PW (R-PDSO-G**)

PLASTIC SMALL-OUTLINE PACKAGE

14 PINS SHOWN



4040064/F 01/97

- NOTES: A. All linear dimensions are in millimeters.
 B. This drawing is subject to change without notice.
 C. Body dimensions do not include mold flash or protrusion not to exceed 0,15.
 D. Falls within JEDEC MO-153

IMPORTANT NOTICE

Texas Instruments Incorporated and its subsidiaries (TI) reserve the right to make corrections, modifications, enhancements, improvements, and other changes to its products and services at any time and to discontinue any product or service without notice. Customers should obtain the latest relevant information before placing orders and should verify that such information is current and complete. All products are sold subject to TI's terms and conditions of sale supplied at the time of order acknowledgment.

TI warrants performance of its hardware products to the specifications applicable at the time of sale in accordance with TI's standard warranty. Testing and other quality control techniques are used to the extent TI deems necessary to support this warranty. Except where mandated by government requirements, testing of all parameters of each product is not necessarily performed.

TI assumes no liability for applications assistance or customer product design. Customers are responsible for their products and applications using TI components. To minimize the risks associated with customer products and applications, customers should provide adequate design and operating safeguards.

TI does not warrant or represent that any license, either express or implied, is granted under any TI patent right, copyright, mask work right, or other TI intellectual property right relating to any combination, machine, or process in which TI products or services are used. Information published by TI regarding third-party products or services does not constitute a license from TI to use such products or services or a warranty or endorsement thereof. Use of such information may require a license from a third party under the patents or other intellectual property of the third party, or a license from TI under the patents or other intellectual property of TI.

Reproduction of TI information in TI data books or data sheets is permissible only if reproduction is without alteration and is accompanied by all associated warranties, conditions, limitations, and notices. Reproduction of this information with alteration is an unfair and deceptive business practice. TI is not responsible or liable for such altered documentation. Information of third parties may be subject to additional restrictions.

Resale of TI products or services with statements different from or beyond the parameters stated by TI for that product or service voids all express and any implied warranties for the associated TI product or service and is an unfair and deceptive business practice. TI is not responsible or liable for any such statements.

TI products are not authorized for use in safety-critical applications (such as life support) where a failure of the TI product would reasonably be expected to cause severe personal injury or death, unless officers of the parties have executed an agreement specifically governing such use. Buyers represent that they have all necessary expertise in the safety and regulatory ramifications of their applications, and acknowledge and agree that they are solely responsible for all legal, regulatory and safety-related requirements concerning their products and any use of TI products in such safety-critical applications, notwithstanding any applications-related information or support that may be provided by TI. Further, Buyers must fully indemnify TI and its representatives against any damages arising out of the use of TI products in such safety-critical applications.

TI products are neither designed nor intended for use in military/aerospace applications or environments unless the TI products are specifically designated by TI as military-grade or "enhanced plastic." Only products designated by TI as military-grade meet military specifications. Buyers acknowledge and agree that any such use of TI products which TI has not designated as military-grade is solely at the Buyer's risk, and that they are solely responsible for compliance with all legal and regulatory requirements in connection with such use.

TI products are neither designed nor intended for use in automotive applications or environments unless the specific TI products are designated by TI as compliant with ISO/TS 16949 requirements. Buyers acknowledge and agree that, if they use any non-designated products in automotive applications, TI will not be responsible for any failure to meet such requirements.

Following are URLs where you can obtain information on other Texas Instruments products and application solutions:

Products

Amplifiers	amplifier.ti.com
Data Converters	dataconverter.ti.com
DSP	dsp.ti.com
Clocks and Timers	www.ti.com/clocks
Interface	interface.ti.com
Logic	logic.ti.com
Power Mgmt	power.ti.com
Microcontrollers	microcontroller.ti.com
RFID	www.ti-rfid.com
RF/IF and ZigBee® Solutions	www.ti.com/lprf

Applications

Audio	www.ti.com/audio
Automotive	www.ti.com/automotive
Broadband	www.ti.com/broadband
Digital Control	www.ti.com/digitalcontrol
Medical	www.ti.com/medical
Military	www.ti.com/military
Optical Networking	www.ti.com/opticalnetwork
Security	www.ti.com/security
Telephony	www.ti.com/telephony
Video & Imaging	www.ti.com/video
Wireless	www.ti.com/wireless

Mailing Address: Texas Instruments, Post Office Box 655303, Dallas, Texas 75265
Copyright © 2008, Texas Instruments Incorporated